



Ардуино радионица



ARDUINO RADIONICA



ATmega328 – interna arhitektura

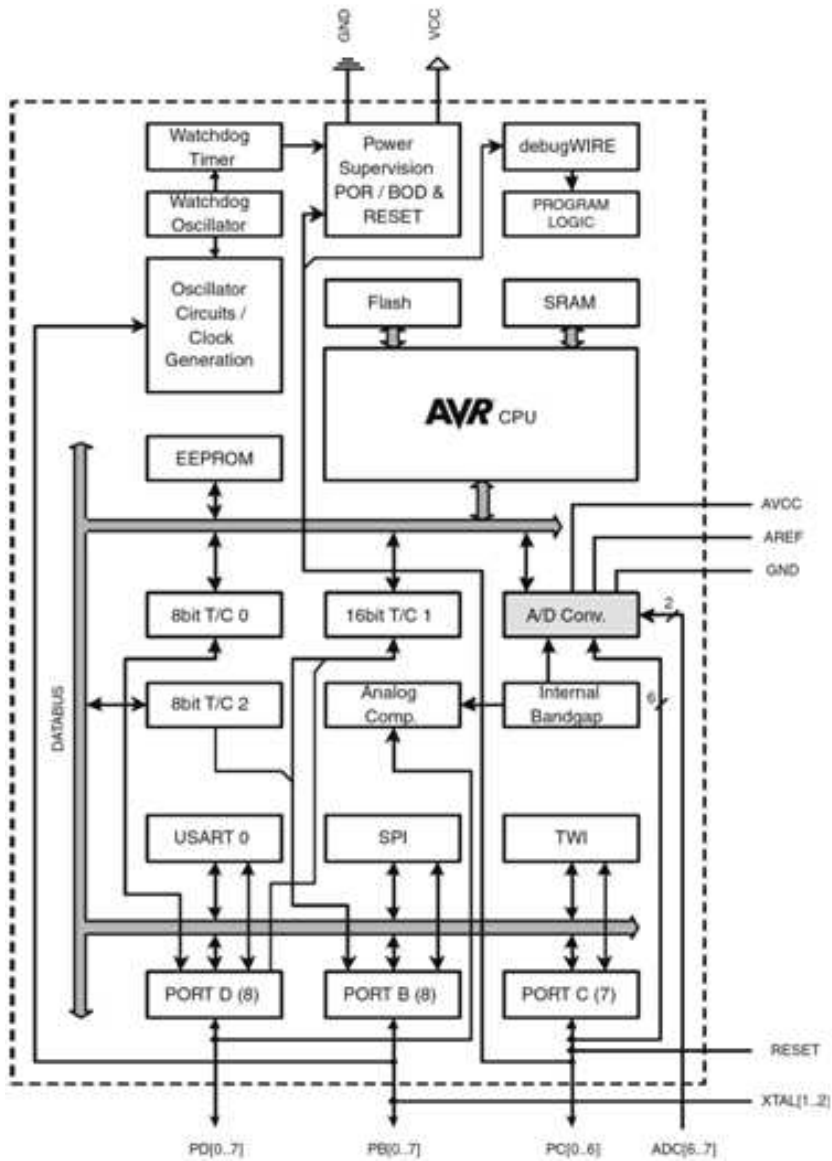

(PCINT14/RESET) PC6	1	28	PC5 (ADC5/SCL/PCINT13)
(PCINT16/RXD) PD0	2	27	PC4 (ADC4/SDA/PCINT12)
(PCINT17/TXD) PD1	3	26	PC3 (ADC3/PCINT11)
(PCINT18/INT0) PD2	4	25	PC2 (ADC2/PCINT10)
(PCINT19/OC2B/INT1) PD3	5	24	PC1 (ADC1/PCINT9)
(PCINT20/XCK/T0) PD4	6	23	PC0 (ADC0/PCINT8)
VCC	7	22	GND
GND	8	21	AREF
(PCINT6/XTAL1/TOSC1) PB6	9	20	AVCC
(PCINT7/XTAL2/TOSC2) PB7	10	19	PB5 (SCK/PCINT5)
(PCINT21/OC0B/T1) PD5	11	18	PB4 (MISO/PCINT4)
(PCINT22/OC0A/AIN0) PD6	12	17	PB3 (MOSI/OC2A/PCINT3)
(PCINT23/AIN1) PD7	13	16	PB2 (\overline{SS} /OC1B/PCINT2)
(PCINT0/CLKO/ICP1) PB0	14	15	PB1 (OC1A/PCINT1)



Microcontroller	ATmega168/328
Operating Voltage	5V
Input Voltage (recommended)	7-12V
Input Voltage (limits)	6-20V
Digital I/O Pins	14 (of which 6 provide PWM output)
Analog Input Pins	6
DC Current per I/O Pin	40 mA
DC Current for 3.3V Pin	50 mA
Flash Memory	16 KB (ATmega168) or 32 KB (ATmega328) of which 2 KB used by bootloader
SRAM	1 KB (ATmega168) or 2 KB (ATmega328)
EEPROM	512 bytes (ATmega168) or 1 KB (ATmega328)
Clock Speed	16 MHz

28.1 Absolute Maximum Ratings*

Operating Temperature	-55°C to +125°C
Storage Temperature	-65°C to +150°C
Voltage on any Pin except $\overline{\text{RESET}}$ with respect to Ground	-0.5V to $V_{CC}+0.5V$
Voltage on $\overline{\text{RESET}}$ with respect to Ground.....	-0.5V to +13.0V
Maximum Operating Voltage	6.0V
DC Current per I/O Pin	40.0 mA
DC Current V_{CC} and GND Pins	200.0 mA

... prikaz komponenti

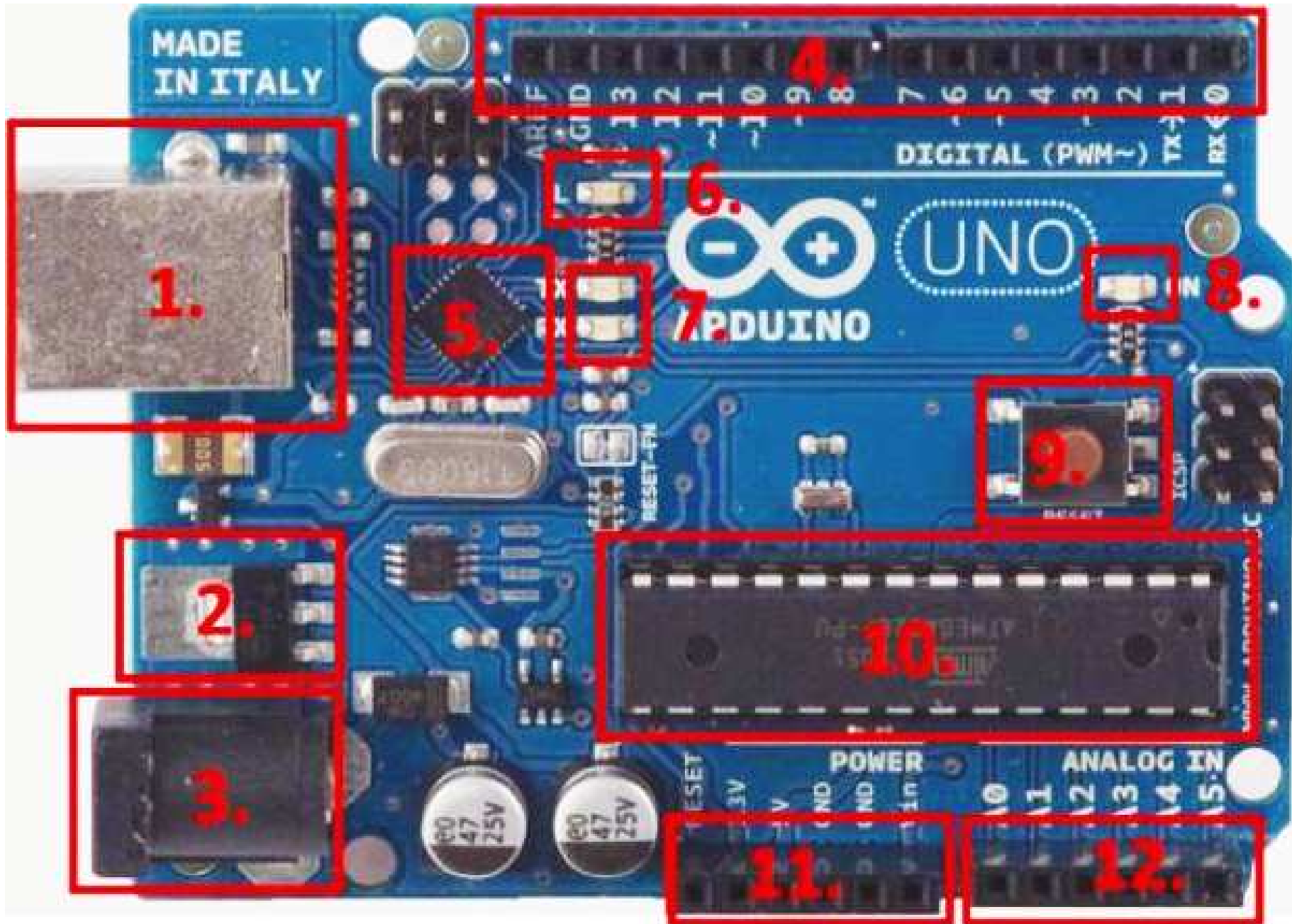



1.	USB priključak
2.	Regulator napona
3.	Priključak za napajanje
4.	Digitalni pinovi
5.	FTDI USB čip
6.	Testna „led“ na pinu 13
7.	TX i RX diode
8.	Dioda koja prikazuje je li Arduino uključen
9.	Reset taster
10.	Mikrokontroler
11.	Pinovi za napajanje
12.	Analogni pinovi

... Arduino MEGA



- Komunikacioni kanali kroz koje protiču informacije u ili iz mikrokontrolera
- Primer Port B
 - Pins PB0 – PB7
 - Ne moraju biti jedan uz drugog
 - Često su dvosmeri

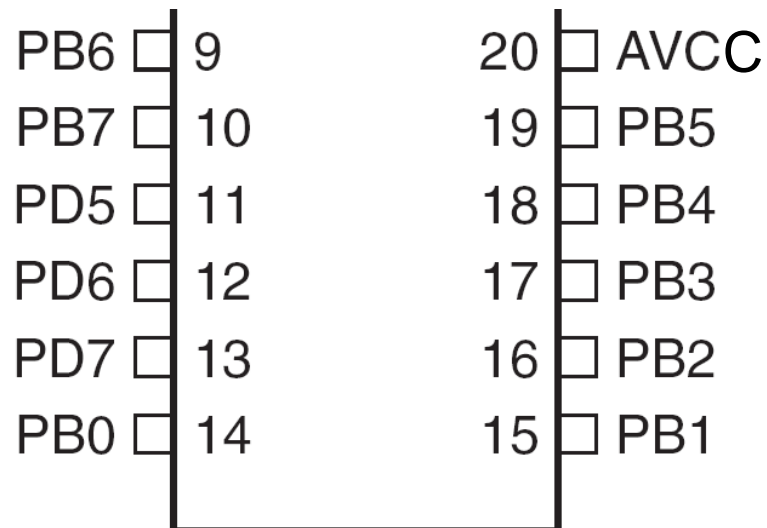

- **Input** – kada je potrebno prihvatiti informaciju iz spoljašnjeg sveta (senzori) u mikrokontroler
- **Output** – kada je potrebno nečemu promeniti stanje a to nešto se nalazi izvan mikrokontrolera (uključiti/isključiti motor itd.)
- Inicijalno, pinovi su definisani kao **Input** pri uključenju napajanja ili posle resetovanja
- **Programskim kodom** se može postaviti ili promeniti usmerenost svakog pina u bilo kom trenutku

ATmega328 – blok dijagram

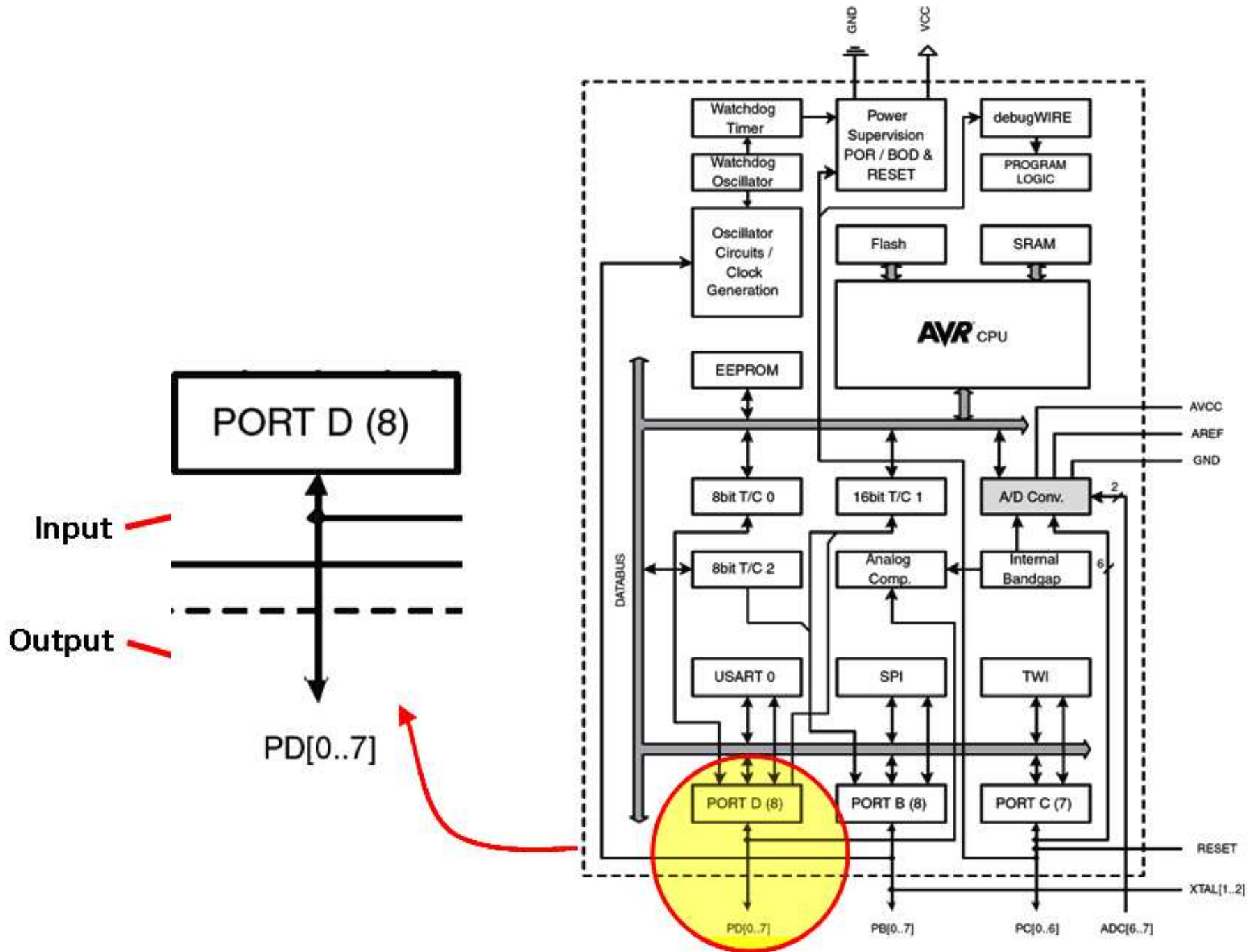

- Arduino
 - `pinMode(pin_no., dir)`
- Primer: Postaviti da Arduino pin 3 (PD3) bude izlazni (*output*)
 - `pinMode(3, OUTPUT);`
- Primer: Postaviti da Arduino pinovi 3, 5, i 7 (PD3, PD5, i PD7) budu izlazni (outputs)

```
pinMode(3, OUTPUT);  
pinMode(5, OUTPUT);  
pinMode(7, OUTPUT);
```

- Mikrokontroleri su u osnovi **digitalni** uređaji. Za digitalne IO pinove važi:
 - Informacija se ‘kodira’ u dva diskretna stanja:
 - HIGH ili LOW (logičko: 1 ili 0)
 - Naponi
 - TTL
 - » 5 V (za HIGH)
 - » 0 V (za LOW)
 - 3.3 V CMOS
 - » 3.3 V (za HIGH)
 - » 0 V (za LOW)

- **Šildovi** (štitovi; engl. shields) su pločice koje se mogu odozgo priključiti (žargonski rečeno - nabadanjem) na Arduino pločicu kako bi se proširile Arduinove mogućnosti. Postoji mnoštvo šildova, a svi slede istu filozofiju kao i Arduino, lako se montiraju i jeftini su za proizvodnju.

- Postavljanje šilda na Arduino pločicu

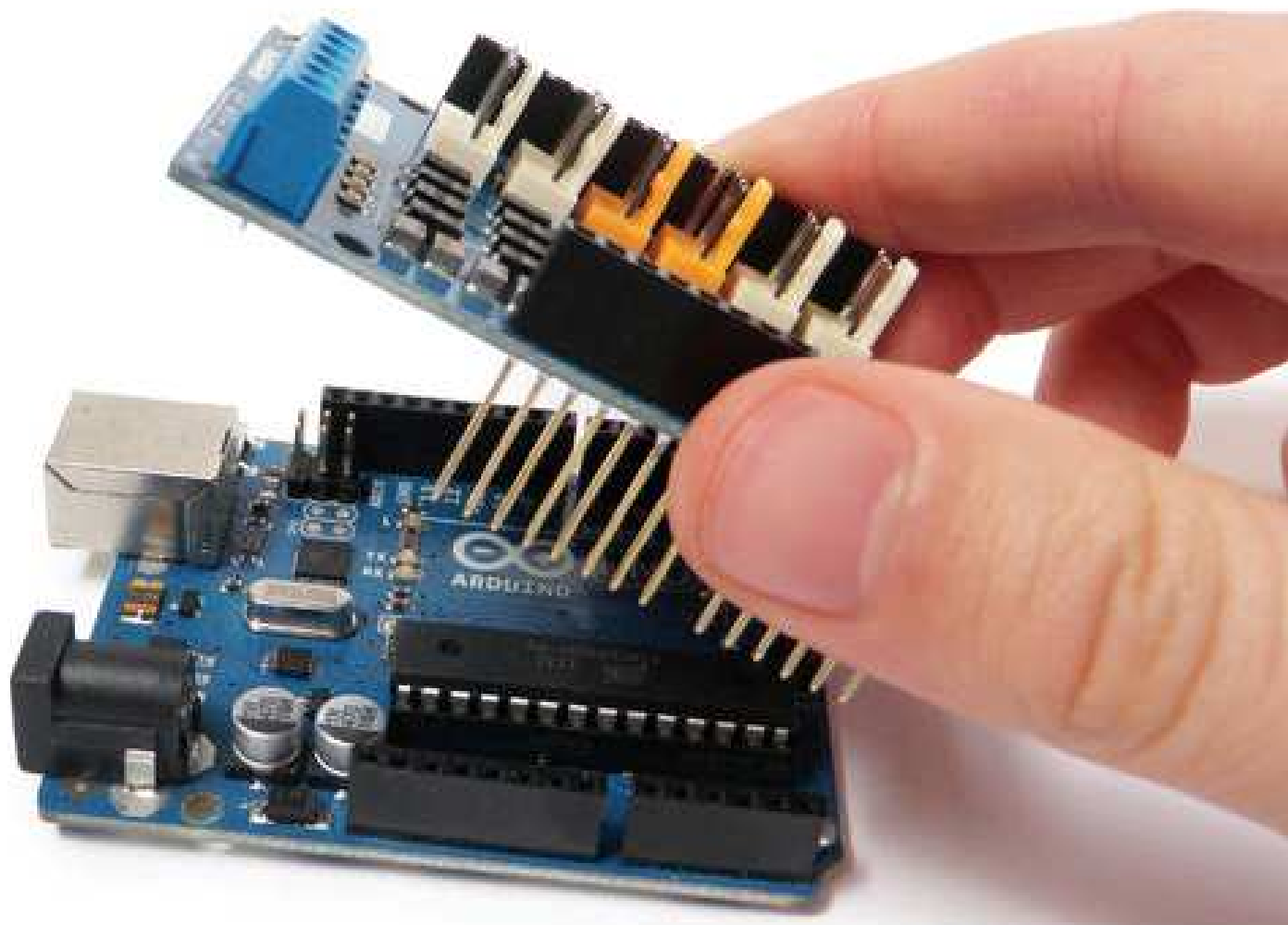

- “nadzidi vanje”

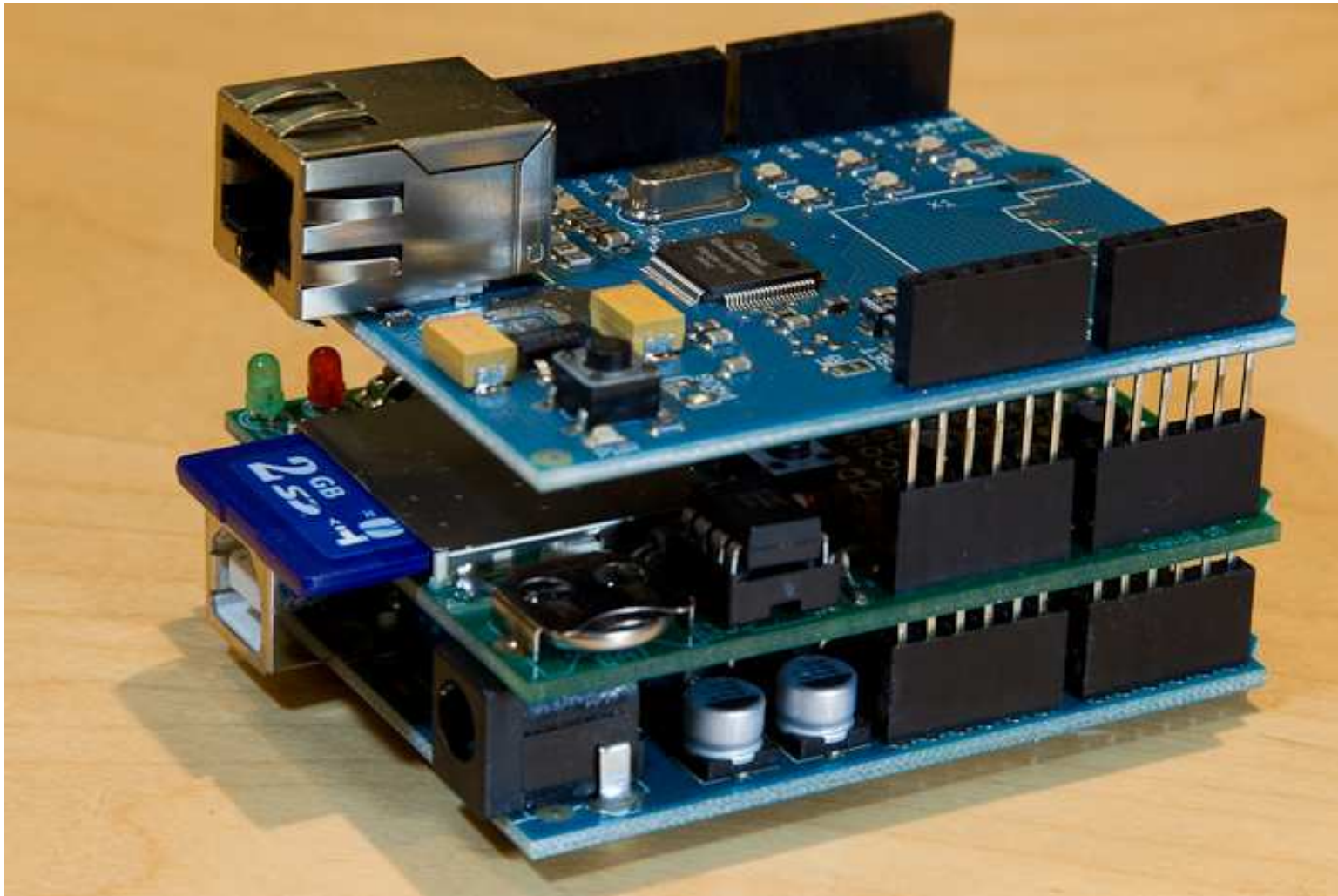

- Proto shield w/mini breadboard

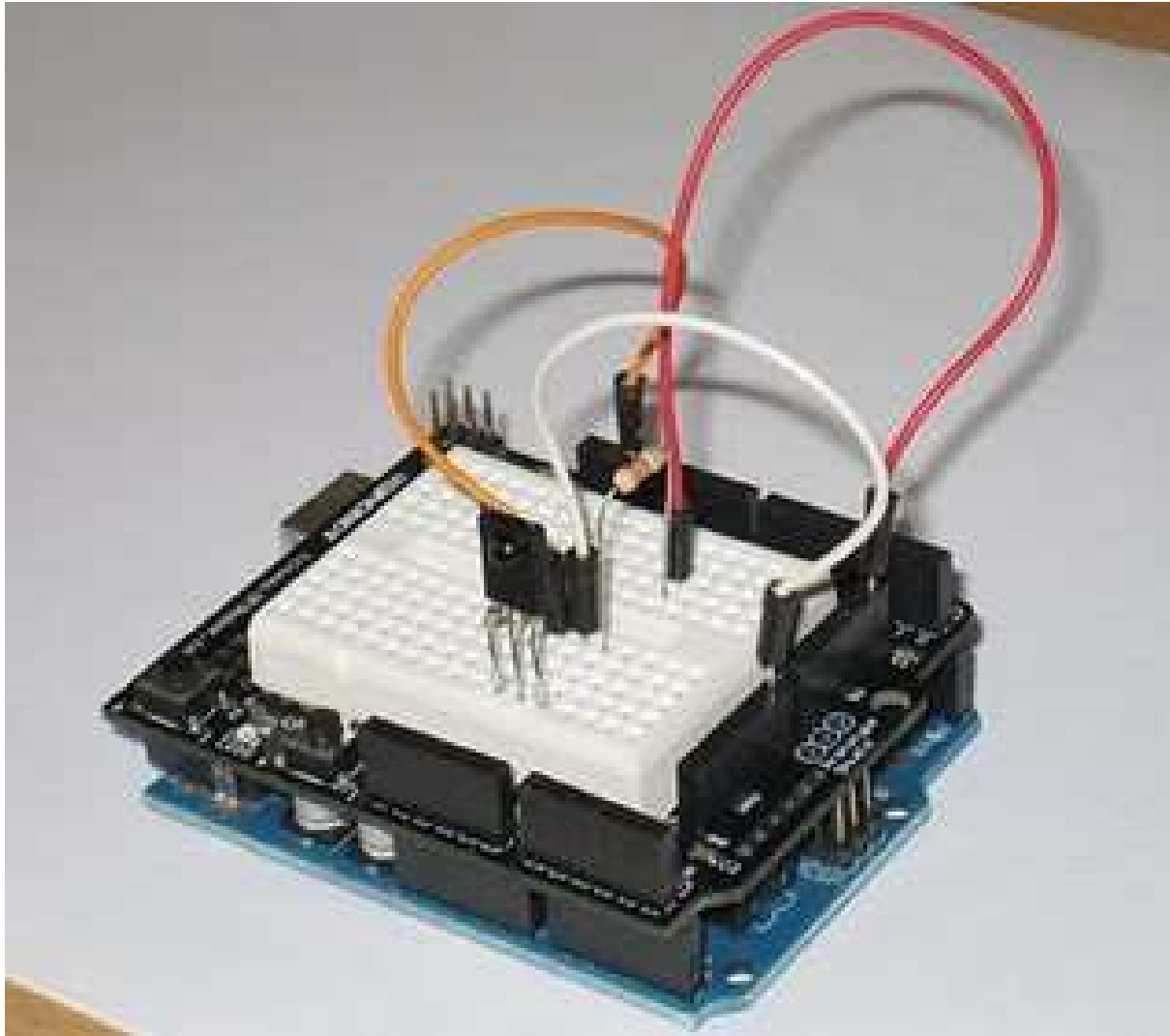

- **Xbee šild + Xbee radio modul,**
- 2,4GHZ – dvosmerni prenos,
- format RS232, naponski nivoi: 0V i 3.3V,
- Domet, napolju 100m a u zatvorenom prostoru 30m.

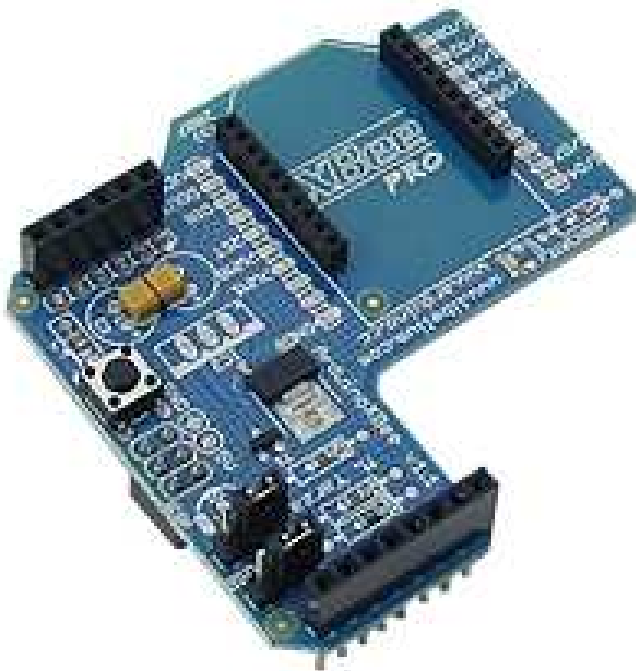

- Ethernet shield w/micro-SD reader

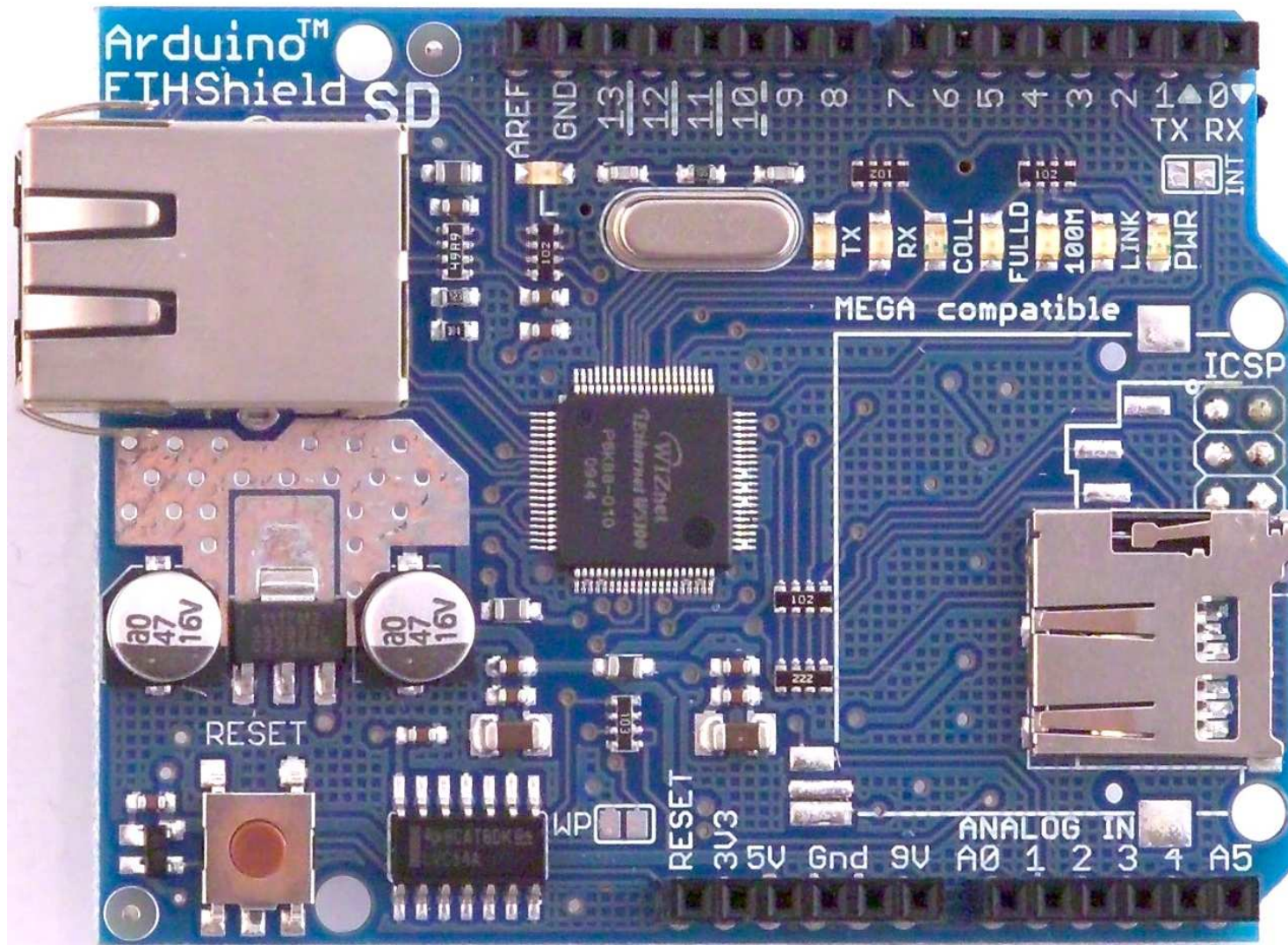

- Adafruit Motor/Stepper/Servo Shield for Arduino

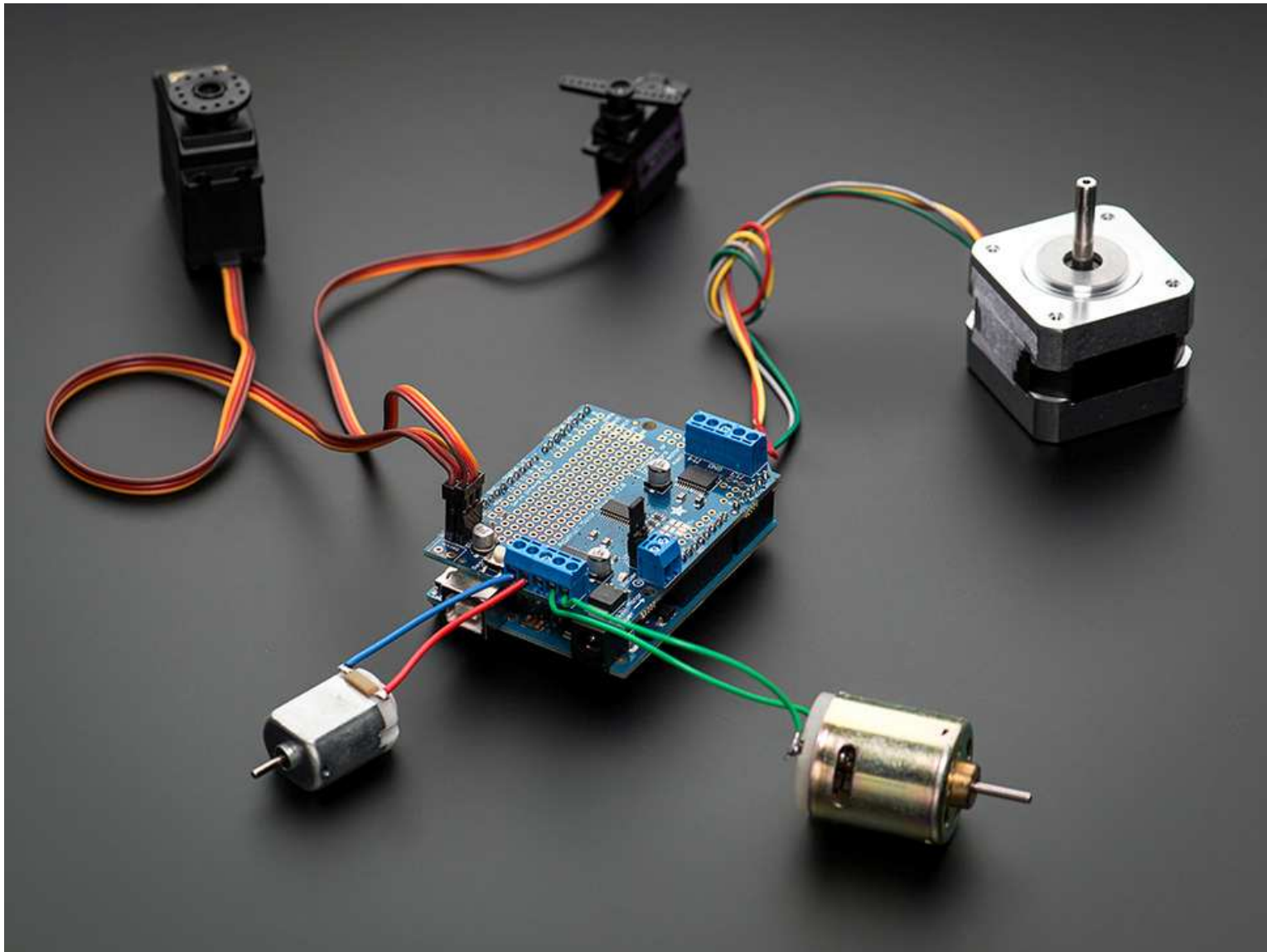

- LCD keypad šild za Arduino



- Seedstudio GPRS šild



GPRS ili General Packet Radio Service je protokol koji omogućava prenos podataka bežičnim putem kroz GSM mrežu. GPRS se koristi na 2G i 3G mreži a omogućava brzinu prenosa podataka između 56 -114 kbit/s.

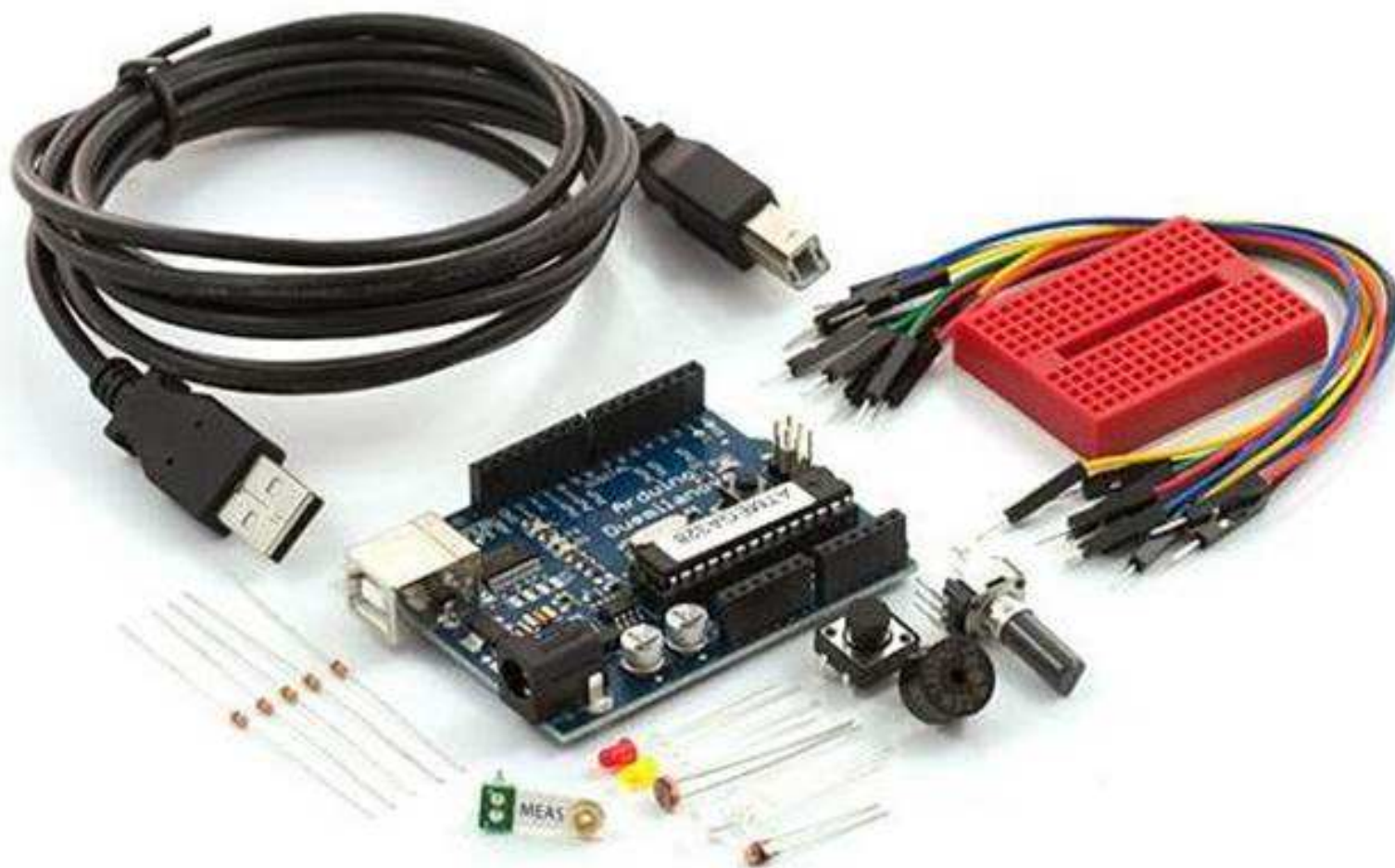

Širmovani (oklopljeni)



Standardni (neoklopljeni)



- Arduino UNO se može napajati preko USB veze ili preko eksternog napajanja. **Izvor napajanja se automatski detektuje.**
- Kod starijih modela (Decimilia) džamperom se selektuje izvor napajanja

barrel connector 2,1 mm to 9v dc



- Прикључивање Arduina na bateriju od 9 V DC



- **QUADBAND MODULE FOR ARDUINO, RASPBERRY PI AND INTEL GALILEO (SIM908)**



- Works with Official Arduino Boards

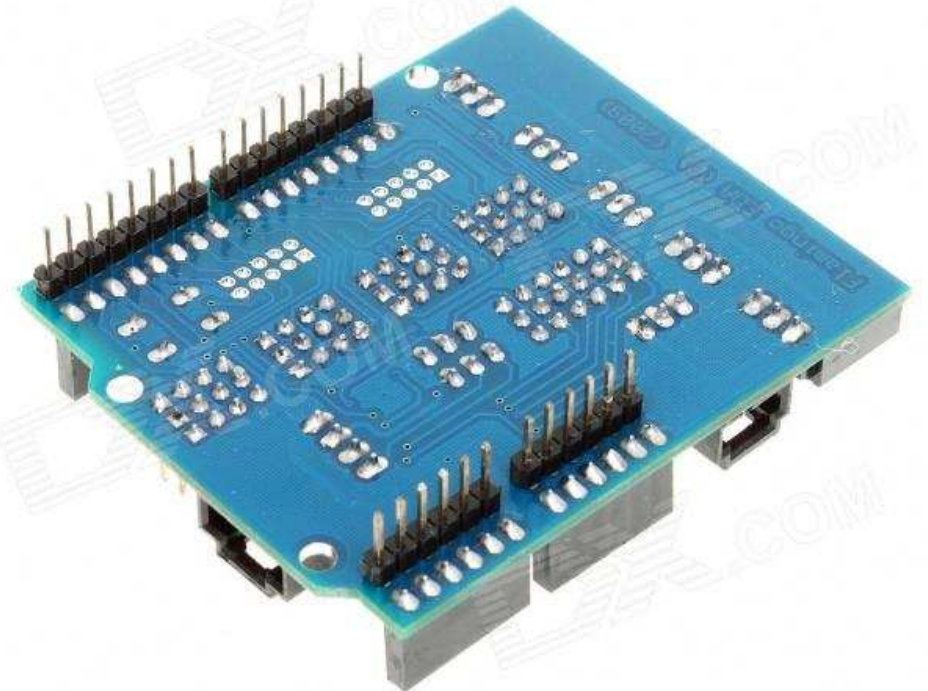

- <http://www.dx.com/>
- www.kelco.rs
- www.mikroprinc.com
- 012lab.com

Ova prezentacija je nekomercijalna.

Slajdovi mogu da sadrže materijale preuzete sa Interneta, stručne i naučne građe, koji su zaštićeni Zakonom o autorskim i srodnim pravima. Ova prezentacija se može koristiti samo privremeno tokom usmenog izlaganja nastavnika u cilju informisanja i upućivanja studenata na dalji stručni, istraživački i naučni rad i u druge svrhe se ne sme koristiti –

Član 44 - Dozvoljeno je bez dozvole autora i bez plaćanja autorske naknade za nekomercijalne svrhe nastave: (1) javno izvođenje ili predstavljanje objavljenih dela u obliku neposrednog poučavanja na nastavi; - ZAKON O AUTORSKOM I SRODNIM PRAVIMA ("Sl. glasnik RS", br. 104/2009 i 99/2011)

Dragan S. Marković